



Toll Free: 1-800-579-8088 Web: www.zinko.com

MODELS

## ZAJ-1008, ZAJ-1510, & ZAJ-2510 20 to 25 Ton Aluminum Journal Mechanical Jacks

### Operating Instructions & Repair Parts List

#### Operation

The owner and/or operator shall have an understanding of these operating instructions and warnings before operating the jack. Warning information shall be emphasized and understood. If the operator is not fluent in English, the instructions and warning shall be read to and discussed with the operator in the operator's native language by the purchaser/owner, making sure that the operator comprehends its contents.

#### WARNING

##### For Your Safety and to Prevent Injury

1. **DO NOT OPERATE JACK BEYOND ITS RATED CAPACITY. DO NOT USE JACK IF DAMAGED.**
2. Install jack on solid base and support jack. Use friction material (concrete, wood, or steel) under base and between jack and load to prevent slipping.
3. **DO NOT APPLY TO SLANT LOADS OR SHOCK LOADS.** Center load on jack. Apply load overall to cap of jack. Unstable load may lead to damage of jack.
4. **DO NOT THROW OR DROP JACK.** Do not use jack in upside down position or in pulling position.
5. **DO NOT USE JACK BEYOND STROKE LIMIT MARK ON RAM (red line).** When using jack over limit mark, jack gets locked and becomes immovable.
6. Do not jack down when cap contacts upper face body. This action may damage the jack.
7. Use the recommended handle lever and insert it fully into the handle lever opening of ratchet, until red mark of handle lever fully disappears. Remove handle lever when not in use and store it safely (be careful not to drop handle lever).
8. **DO NOT GET UNDERNEATH LOAD.** Take safety measures to prevent workers from passing under load until it is secured by blocking.

#### Inspection

1. Visual inspection shall be made before each use of the jack, checking for leaking hydraulic fluid, and damaged, loose or missing parts.
2. Each jack shall be inspected by an authorized **ZINKO** service facility immediately, if subjected to an abnormal load or shock.
3. Owners and/or users should be aware that repair of this equipment may require specialized knowledge and facilities. It is recommended that an annual inspection of the jack be made by an authorized **ZINKO** service facility and that any defective parts, decals or warning labels be replaced with genuine **ZINKO** parts. A list of authorized service facilities is available from **ZINKO**.

#### Damaged Jacks

Any jack which appears to be damaged in any way, is found to be badly worn, or operates abnormally SHALL BE REMOVED FROM SERVICE until necessary repairs are made by an authorized **ZINKO** service facility.

#### Operating Instructions (Before Use)

1. Turn the ratchet handle to check whether ram goes up and down smoothly. Screw the 2-piece aluminum handle together before use.
2. Inspect condition visually before placing under or supporting load. Make sure jack has correct capacity.
3. Push the liner of the ratchet handle to "UP" position and operate the handle lever up and down. Then push the liner of the ratchet handle to "DOWN" position and operate the handle lever up and down.

#### Using the Jack

1. Operation must be done by hand operated lever. Make sure to insert the handle lever into the bottom of ratchet handle. NOTE: Incomplete insertion of the handle lever leads to slipping off during operation).
2. Make sure that ground is level and stable where jack is placed. Make sure jacks has enough space to operate and adjust safely. NOTE: The jack is designed for indoor use only. However, in case of outdoor use, jack is not protected from rain and water.
3. Use a friction material (wood or paper) between cap of jack and load. This protects the load from slipping off.

#### Using More Than One Jack

1. Load may tend to be applied unevenly to each jack. When using multiple jacks; **MAKE SURE ALL JACKS BEING USED HAVE THE CORRECT CAPACITY FOR YOUR APPLICATION.** Use jack no higher than **50% TO 70%** of rated capacity.
2. Take care of movement load when operating multiple jacks. Determine operation order of each jack in advance making sure the load is well balanced and in the correct position.

# Zinko Hydraulic Jack

## Model: ZAJ Series Parts Breakdown

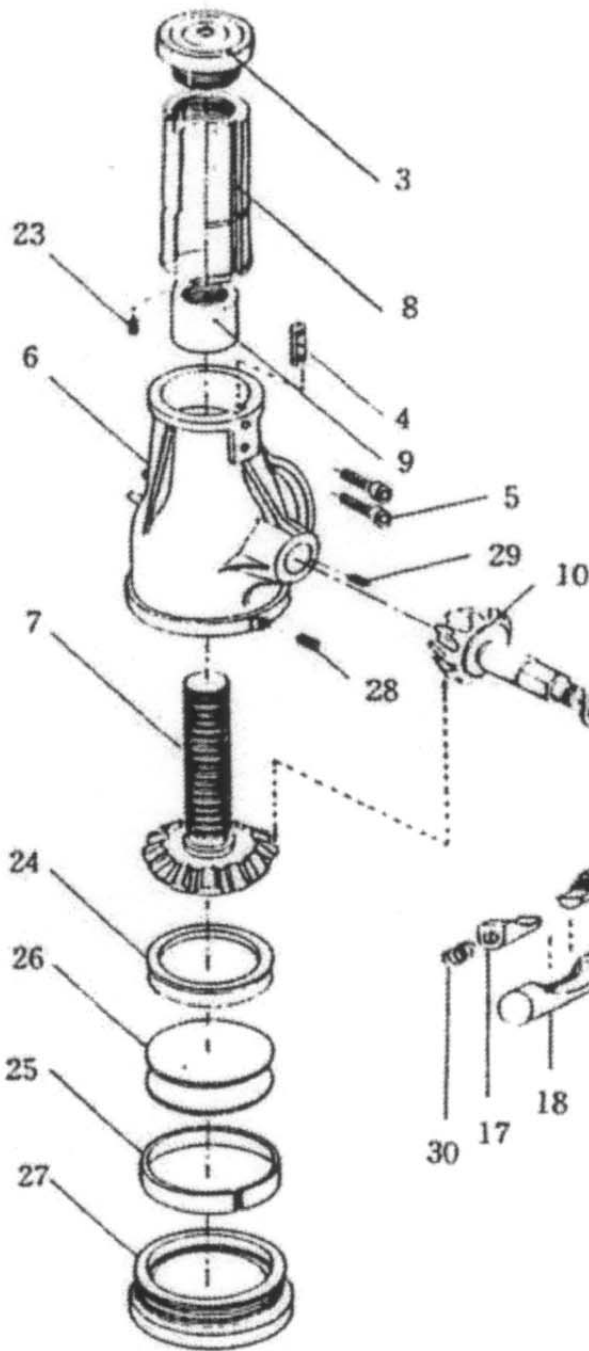

#	Description
3	CAP
4	KEY
5	BOLT
6	BODY
7	SCREW & GEAR
8	RAM
9	FEMALE NUT
10	BEVEL PINION
11	WASHER
12	PINION BUSH
13	RATCHET CAP
14	SET SCREW
15	SPRING
16	STEEL BALL
17	PLUNGER

#	Description
18	LINER
19	WHEEL
20	SNAP RING
21	WASHER
22	HANDLE SOCKET
23	SET SCREW
24	PLATE
25	BUSH
26	PAD
27	BASE
28	SET SCREW
29	SET SCREW
30	SPRING
31	HANDLE LEVER

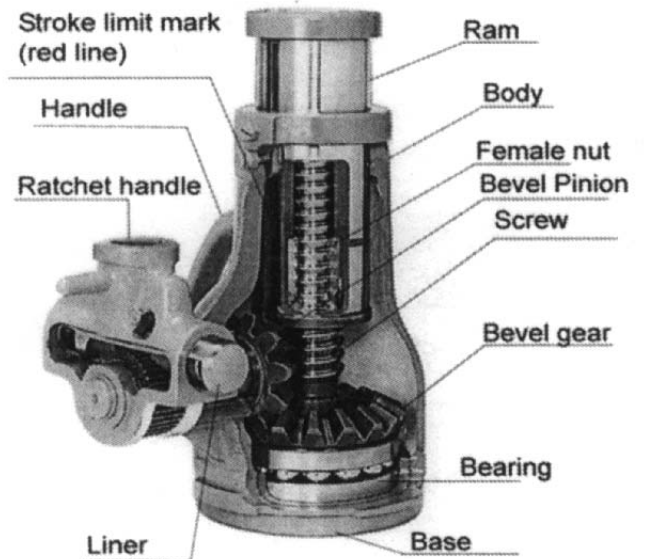
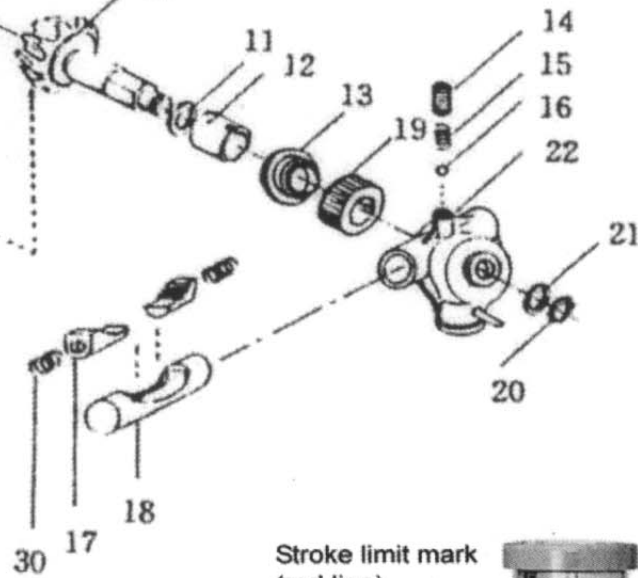

# Zinko Hydraulic Jack

REV 062707

## Model: ZAJ Series

### Maintenance

1. **Lubrication.** (rust-resistant and supply of grease)  
Completely eliminate dust and apply grease regularly to prevent rust.
2. **Cleaning.**  
Jacks exposed to rain, sand, or grit-laden air should be cleaned prior to storage and use. Jack operating lever and load-bearing surfaces should be free of slippery materials and fluids
3. **Storing Jack.** Jacks should be stored where protected from the elements, abrasive dust, and other damage.

## SAFETY PRECAUTIONS

*Safety shoes, gloves, helmet, and clothes are recommended to protect operators' safety.*

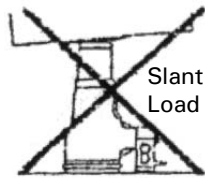

Slant Load

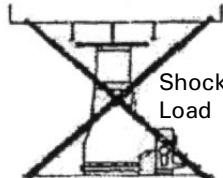

Shock Load

- 1) Do not apply slant loads or shock loads to jack.

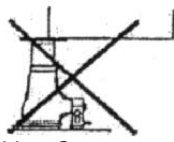

Line Contact

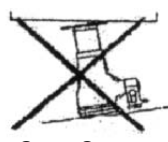

Spot Contact

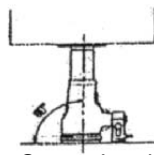

Center Load

- 2) Center load on jack. Apply load overall to cap of jack. Unstable load may lead to damage of jack.

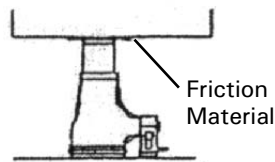
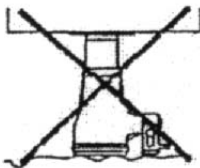

Friction Material

- 3) Set jack to concrete, wood, or steel base which is strong enough to endure load.

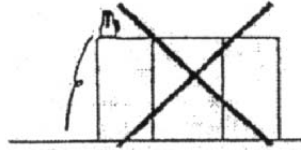

- 4) Do not throw or drop jack (especially ZAJ series).

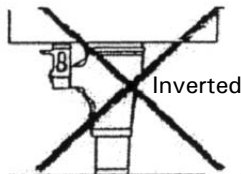

Inverted

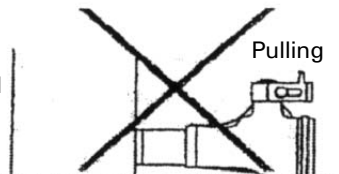

Pulling

- 5) Do not use the jack in upside down or pulling position.

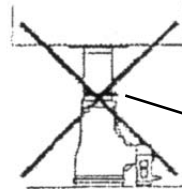

Stroke Limit Mark (red line)

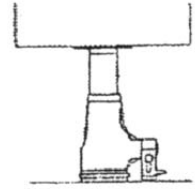

- 6) Do not use jack beyond stroke limit mark on ram (red line) When using jack over limit mark, jack becomes locked and immovable.

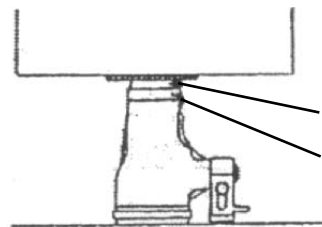

Lower face of cap  
Upper face of body

- 7) Do not jack down when cap contacts upper face body. When jack down is continued, jack may be damaged.

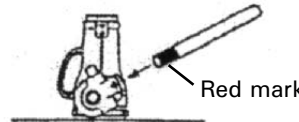

Red mark

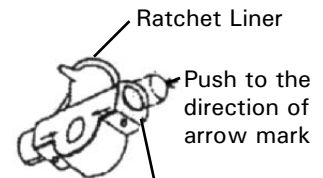

Ratchet Liner  
Push to the direction of arrow mark

Insert handle all the way into position



One-piece handle (ZJJ series)



Two-piece handle (ZAJ series)

- 8) Use the recommended handle lever and insert it fully into the handle lever opening of ratchet until red mark on handle lever disappears.

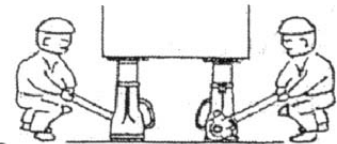

- 9) Keep out of being under the load. Prevent workers from passing under load until it is secured by blocking.